

**THE DURO-M.
FROM RÖHM.**



**IF YOU'RE LOOKING FOR A
LATHE CHUCK THAT WILL
TAKE YOU THE DISTANCE.**





**TRUE
FRIENDSHIP
DEVELOPS
OVER TIME.**

**TRUE FRIENDSHIP
MEANS BEING
ABLE TO RELY ON
EACH OTHER.**





**TRUE
FRIENDSHIP
LASTS A
LIFETIME.**



**WE ARE
CONTINUING
THE STORY.**

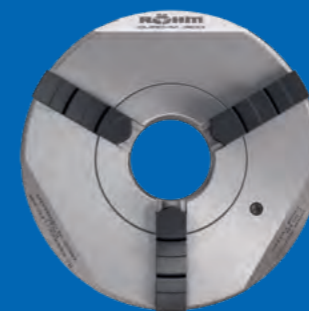

**THE NEW
DURO-M
SCROLL CHUCK.
FROM RÖHM.**

* Like its predecessors, the new scroll chuck is developed and produced for you in Germany.

THERE'S A DURO-M FOR EVERY APPLICATION

The DURO-M is a manually scroll chuck with through-hole. It is mainly used on manual turning machines for machining turned parts.

The chuck body of the DURO-M is made entirely of steel and designed for optimum accessibility, but at the same time is weight and mass inertia optimized. A drip edge for coolant is incorporated around the circumference. The end face is scalloped towards the edges.

The DURO-M is available in a two, three, four or six-jaw design. Available connections are cylindrical mounting (mounting from the rear [DIN6350, form A], mounting from the front [DIN6350, modified]), short taper mounting (mounting from the front [ISO 702-1/DIN 55026], Camlock [ISO 702-2/DIN 55029], and bayonet [ISO 702-3/DIN 55027]).

As an option, the DURO-M is also available with double jaw guide.

The DURO-M is supplied complete with either a set of inside and outside jaws or a set of base and reversible jaws. The jaws are finish ground at the factory to fit your chuck.

DESIGNED FOR

Conventional clamping horizontal and vertical turning machines, as well as milling machines, rotary tables and dividing attachments. Predominantly for use in single or small batch production or in repair shops.

APPLICATION

Clamping of rotationally symmetrical parts for turning and milling

BENEFITS

- Very wide range of diameters (starting at Ø74 mm up to Ø1250 mm – larger on request)
- Chuck body (and all other components) made of steel
- All standard spindle interfaces
- Choice of 2, 3, 4 and 6-jaw chuck
- Optionally with double guide
- High clamping force
- High concentricity up to 0.02 mm
- Jaws with gunmetal finish
- Weight and mass inertia optimized
- Minimal interference contour

WHY IT'S A WISE INVESTMENT

- Excellent value for money

CHOOSING A DURO-M IS THE BEGINNING OF A LONG FRIENDSHIP

For clamping turned parts on manual turning machines.

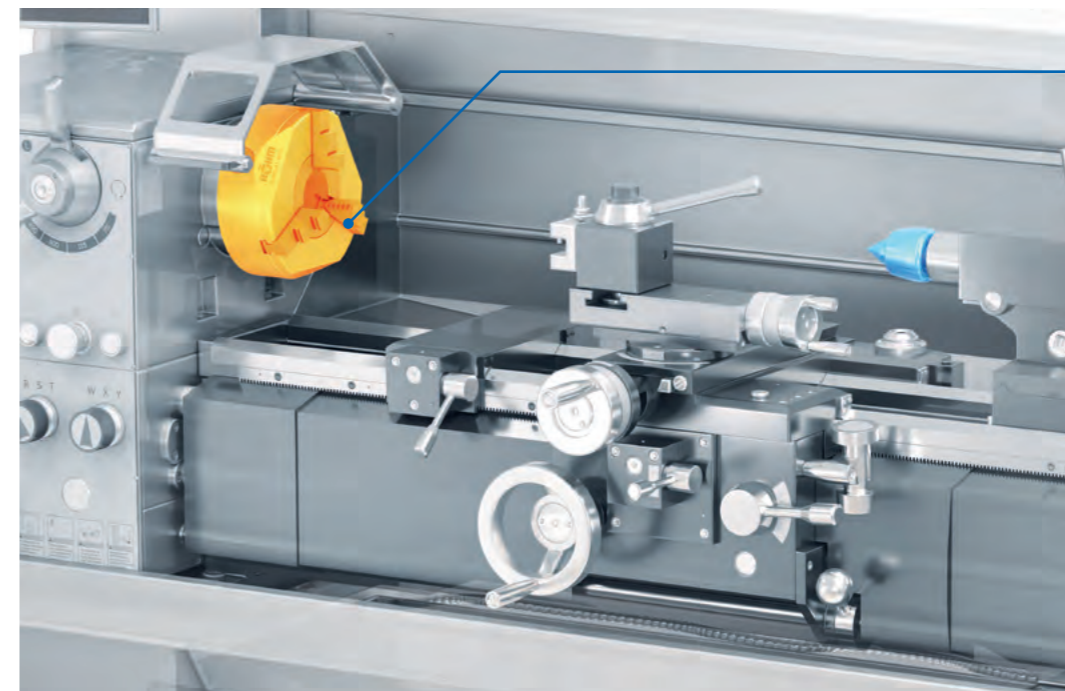

DURO-M lathe chucks

Compatible accessories and spare parts

At RÖHM we believe designing lathe chucks is about more than just offering high quality chucks. We think everything surrounding them is important too. We are interested in the question of what else you might need to make optimum use of RÖHM solutions. Over many years, this has enabled us to develop not just a comprehensive range of jaws, but also a large number of other useful accessories.

Offering the right spare parts is important to us too. Even with the most careful upkeep, things can get broken. So it's useful if a brand manufacturer like RÖHM offers a matching spare part. True friendship lasts a lifetime.

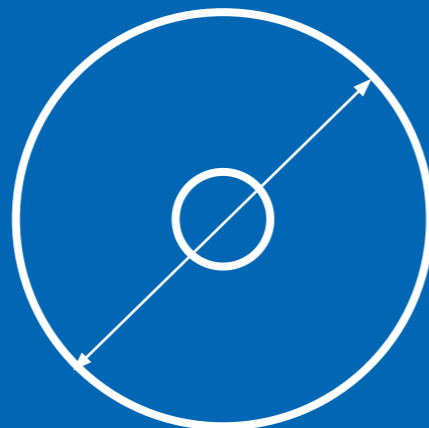

The smallest DURO-M measures just 74 mm in diameter.

HOW DO WE MANAGE TO CREATE OUR MANUAL SCROLL CHUCK SO THAT IT WILL GO THE WHOLE DISTANCE WITH YOU?



1.

THE DESIGN

Characteristic scallops for weight reduction and good accessibility

Let's start with what's most visible – specifically the parts that are missing: on the base body of the DURO-M we have machined the characteristic scallops. This brings you tangible benefits. Firstly in terms of weight. It makes the DURO-M lighter. This not only protects the bearings of your turning machine spindle, it also allows greater acceleration due to the lower mass inertia, and thus reduces energy consumption.

Single-part base body for high rigidity

Have you noticed how few screws you can see on the DURO-M? That's because chuck body is made from one piece of steel. This not only makes it look great and avoids chip accumulations, it primarily makes it extremely rigid. This is the main requirement for accuracy.

Drip edge for controlled coolant drainage

What is actually the job of the little recess on the outside of the chuck body? It ensures controlled drainage of coolant from the edge. Our developers call it a drip edge.

Optimum force transmission

The DURO-M has the highest force transmission of all scroll chucks. And not just on paper - this is a genuine benefit: firstly it means that you have to supply - comparatively - lower forces to obtain the maximum clamping force. And this maximum clamping force is also one of the highest available. Secondly, it means that you can adjust the clamping force much more precisely. The DURO-M is very responsive to adjustment. And this smart design also has another tangible benefit: the higher force transmission saves on height. So the DURO-M has a lower profile in comparison to other options. This means more working envelope. And less height also means less material – making the DURO-M potentially lighter, which not only saves energy but also allows higher speeds. How we achieve this high force transmission technologically is explained in the next section, "The scroll ring". Or, in anticipation: Made in Germany.



2.

THE SCROLL RING

At the heart of every plane scroll chuck is the scroll ring. It is responsible for translating the torque at the chuck key into the clamping force on the jaws. The shape of the tothing, its design, the choice of materials and the finish are the result of RÖHM's decades of experience. The thread flanks are ground on both sides. This is the attention to detail and careful engineering you expect from Roehm.

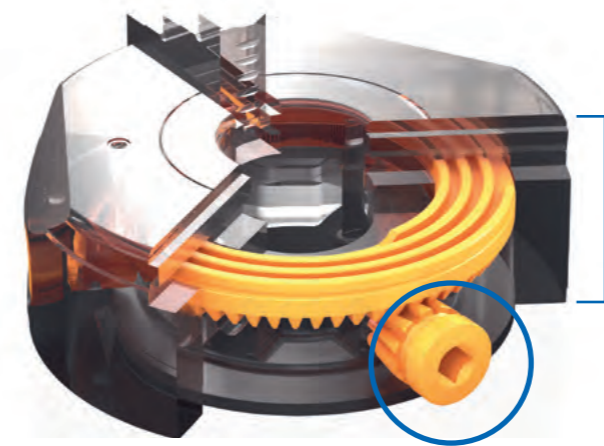

High force transmission for precision adjustment and low height.

3.

MADE IN GERMANY

The DURO-M is a typical "Made in Germany" RÖHM product. At Dillingen an der Donau in Bavaria, we have spent decades producing lathe chucks that are among the very best in the world. We combine state of the art CNC machining technology and a smart production line with our many years of production experience. We mean "production at RÖHM" quite literally, as even the metallurgical processes such as tempering of the components are carried out in our in-house "tempering" center of competence. We spare no details when it comes to our life-long friendships.

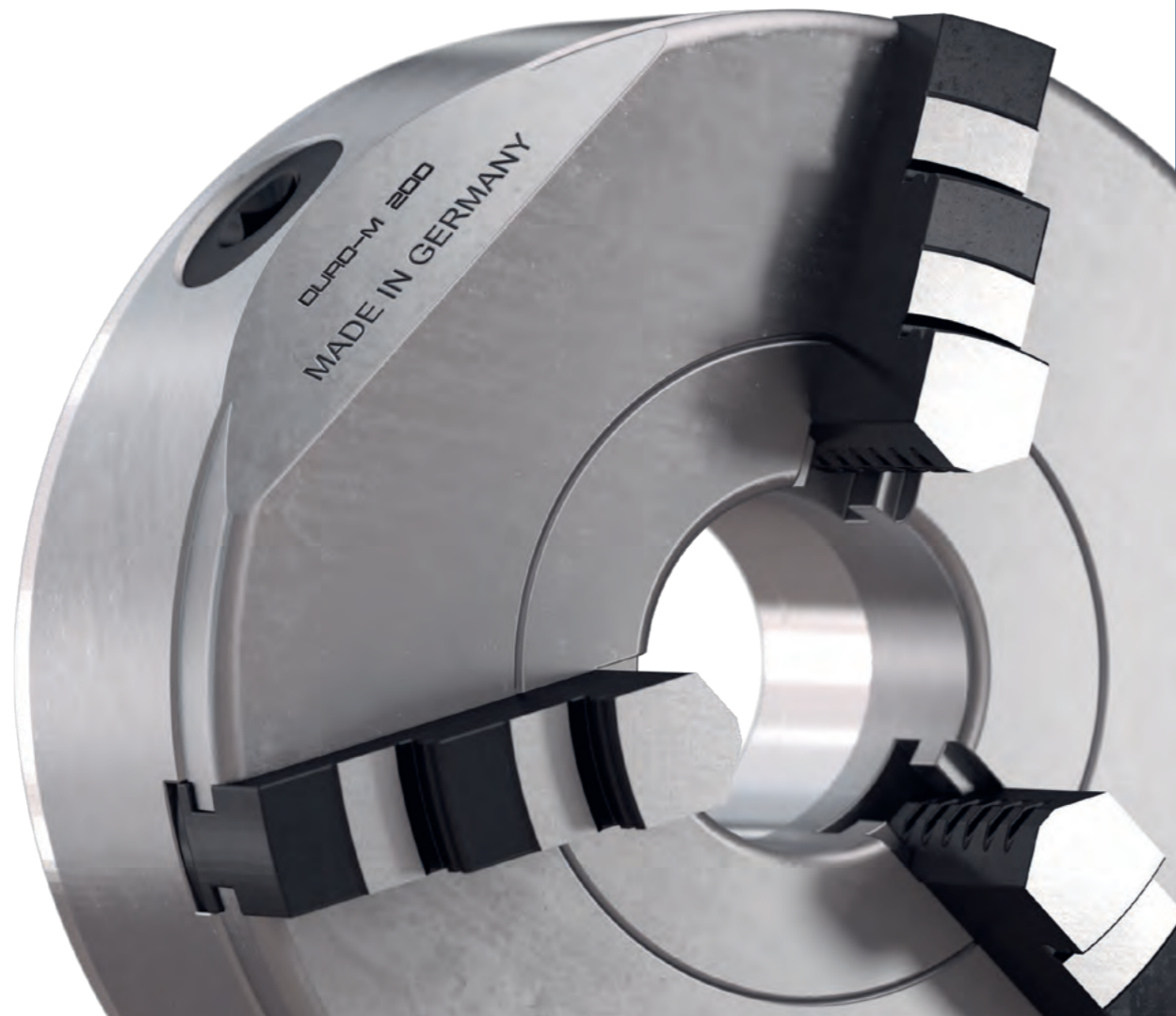

”
DO YOU
STILL REMEMBER
THE LATHE
CHUCK YOU
USED WHEN
YOU FIRST
LEARNED
TURNING?
IT'S VERY
LIKELY THAT IT
WAS A RÖHM
MANUAL SCROLL
CHUCK.

“

RÖHM

THE CHECKPOINT THAT GIVES YOU GUIDANCE ALONG THE WAY



Zero drive determined in the factory as precision drive

Every mechanical system has tolerances due to its principle. We wouldn't be RÖHM if we were not always looking for solutions to achieve the best possible precision. One of these is known as the "zero drive". After installing the chuck, we measure which of the drives is the most precise. We then mark it with an arrow. What is it used for? We use the zero drive when grinding your jaws (see below). You can use this drive for clamping if you have exceptionally demanding concentricity requirements or if you want to measure your machine/clamping system's concentricity (you can find further information in your DURO-M's operating instructions).



ETERNAL YOUTH

Gunmetal jaws for permanent surface protection

Inside and outside jaws and top jaws are identifiable from a distance. We give the jaws of our DURO-M a gunmetal finish. The characteristic black color not only looks good, it also permanently protects the jaw surface. Helping you go the full distance with your jaws.

INDIVIDUAL ADAPTATION PROVES ITS WORTH OVER LONG DISTANCES AND IN PRECISION

4x factory finish ground jaws for high precision

Your DURO-M comes with either a set of inside and outside jaws or a set of reversible top jaws (including base jaws). For maximum precision, we adapt your clamping jaws for your DURO-M chuck at the RÖHM factory. This is done by grinding the jaws (when mounted) on your chuck. For optimum precision, the grinding is carried out on what is known as the "zero drive" (see above). Top jaws are paired with the base jaws.

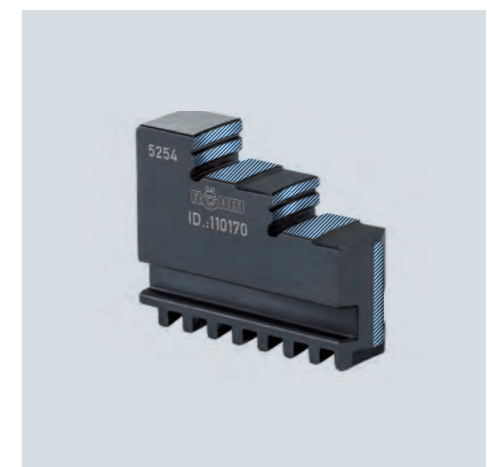
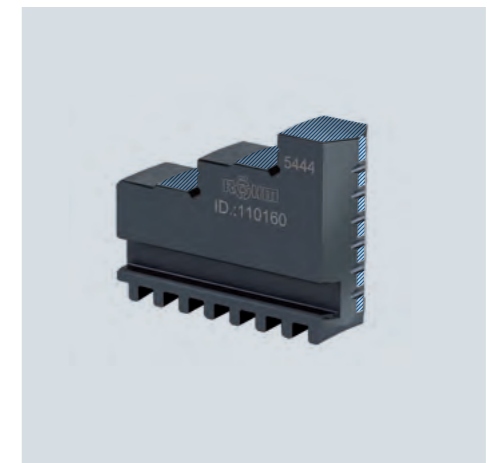

All four surfaces for internal and external clamping are finish ground on the inside and outside jaws and the top jaws on the chuck (l to r).

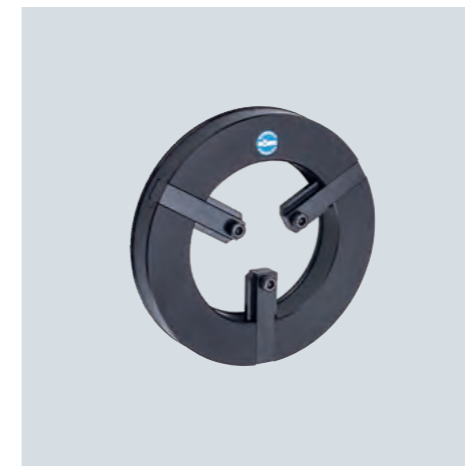

Our jaw finishing device also enables you to grind jaws yourself.

TRAVELING THE NARROWEST PATHS

Precision design for even higher concentricity

Our designers send the DURO-M out into the world with excellent concentricity. But still, there's nothing that can't be made even better. If you need it, we can individually adapt the clamping components - chuck body, scroll ring and jaws - to one another. How does that benefit you? Even higher concentricity. Across all three jaw steps. This option is available in two accuracy levels.

If you want to order the increased precision for your DURO-M, specify the ID number of the required accuracy level on your purchase order, in addition to the ID number of the DURO-M.

By means of adjusting screws between the chuck flange and chuck body the rotational axes of the spindle and centrally clamped workpieces in the chuck can be adjusted to each other with great precision. This enables either centric or eccentric machining on the clamped workpiece (max. 0.3 mm).



In contrast with the Hi-Tru, in the ES version the 3 or 4 clamping jaws can be adjusted individually to each other, thus allowing adaptation to the clamping geometry (e.g. cast components). This means that a defined positioning of the workpiece in relation to the chuck's center of rotation is possible.



Chuck size	74	80	100	125	140	160	200	250
Concentricity		0.03	0.03	0.03	0.03	0.03	0.04	0.04
ID#		902032	902038	902048	902051	902038	902059	902068
Concentricity	-	0.02	0.02		0.02	0.02	0.03	0.03
ID#		902078	902088		902072	902088	902115	902114

Chuck size	315	400	500	630	700	800
Concentricity	0.05	0.06	0.08	0.08	0.1	0.1
ID#	902087	902131	902163	902198	902257	902312
Concentricity	0.04	0.04	0.05	0.05	-	-
ID#	902141	902162	902197	902268	-	-

SOMETIMES A DIVERSION REDUCES THE DISTANCE TO THE DESTINATION

Alternative for exceptionally small machining diameters

Sometimes it makes sense to look for the right solution somewhere unusual. So choosing RÖHM is a good idea as you won't have to search for long.

Because of the principle behind them, scroll chucks have a natural limit in terms of miniaturization. As the components get smaller and smaller, the system reaches a limit for total rigidity. And the precision and service life requirements that you and our developers have for a good lathe chuck can no longer be achieved. So how can workpieces with an exceptionally small diameter be clamped? RÖHM offers an extensive range of precise and robust drill chucks for professional industrial and trade applications. This enables even the very smallest diameters to be clamped with repeat accuracy and excellent concentricity.



Alternative to a lathe chuck for clamping even the smallest diameters: RÖHM drill chucks with clamping ranges of 0-16mm (above: SPIRO below: SUPRA).

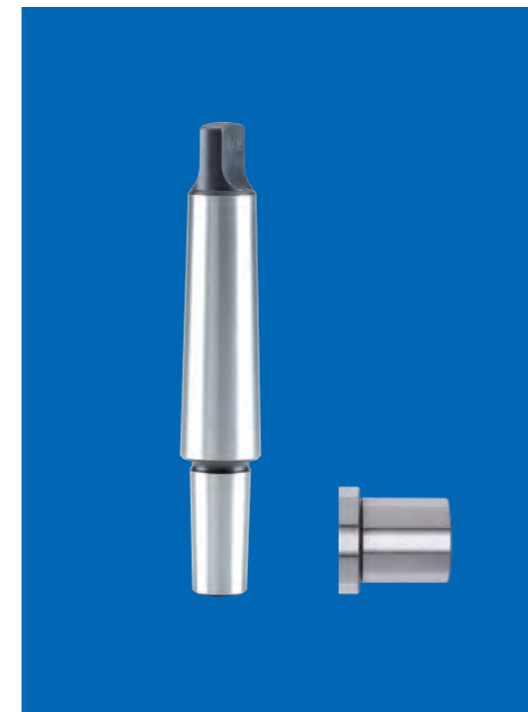

To adapt a drill chuck for your machine tool, RÖHM produces corresponding tapered mandrels (for cylindrical mountings or for clamping in a chuck you will find a compatible sleeve from RÖHM (left)).

GOING THE DISTANCE

RÖHM jaws. For any application.

The tothing of the jaws on the underside – the “base jaw” – engages directly in the guideways on the spiral ring. Jaws for the DURO-M are available in two different designs, either with integrated base jaw, in which case the base jaw and clamping surface are combined in one component. Or with a separate base jaw, in which case

the tothing is part of the base jaw and the clamping surfaces are part of the top jaw. The base and top jaw have (primarily) a positive-locking connection using a tongue and groove and screws.

INSIDE/OUTSIDE JAW



When you order your DURO-M you can choose between a set of one-piece inside jaws and a set of outside jaws, or ...

VS

BASE/TOP JAW

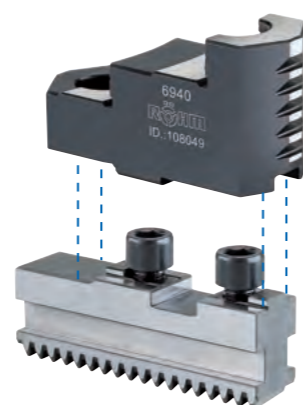

... a jaw set consisting of a base jaw with stepped reversible top jaws

MOUNTING SCREWS FOR TOP JAWS

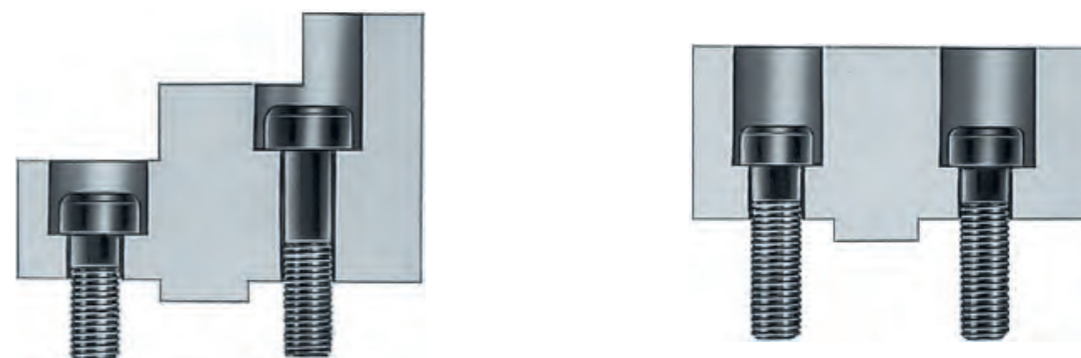

Left: Short, right: Long

Short

Chuck size	74	80	100	125	160	200	250	315
Long			249299	236949	334571	334571	233025	233026
Short			216528	233058	233058	233058	227692	233030

Chuck size	350	400	500	630	800	1000	1250
Long	220565	220565	249003				
Short	220564	220564	233047	233047			



THE RÖHM CLAMPING JAW FINDER

www.roehm.biz/spannjaw-finder

You can find the perfect clamping jaws for your DURO-M very easily using the RÖHM clamping jaw finder on our website:

www.roehm.biz/spannjaw-finder

	74	80	100	125	140
--	----	----	-----	-----	-----

Base jaw



2-Jaw set			108950	10951	10952
3-Jaw set			107500	107501	107502
4-Jaw set			107542	107543	107544
6-Jaw set					

Inside jaw
graduated outwards

HARDENED



3-Jaw set	110154	110155	110156	110157	110158
4-Jaw set		110063	110064	110065	110066
6-Jaw set					

Outside jaw
graduated inwards

HARDENED



3-Jaw set		110165	110166	110167	110168
4-Jaw set		110073	110074	110075	110076
6-Jaw set					

Reverse top jaw
for internal and external clamping

HARDENED



3-Jaw set			108045	108046	
4-Jaw set			108053	108054	
6-Jaw set					

Unstepped jaw
Unstepped

SOFT



3-Jaw set	109114	107588	107589	107590	107591
4-Jaw set	149304	107598	107599	107600	107601
6-Jaw set					

Top jaw
Unstepped

SOFT



2-Jaw set			109497	109498	109499
3-Jaw set			107633	107634	
4-Jaw set			107641	107642	

160	200	250	315	350	400	500	630	800	1000	1250
-----	-----	-----	-----	-----	-----	-----	-----	-----	------	------

108953	108954	108955	108956	108957	108957					
107503	107504	107505	107506	107507	107507	107508	107509	105272	105274	105275
107545	107546	107547	107548	107549	107549	107550	107551	141646	141611	141614
150650	150651	150652	150653	150654	150654					

110159	110160	110161	110162	110163	110163	110164	110164			
110067	110068	110069	110070	110071	110071	110072	110072			
150633	150634	150635	150636	150637	150637					

110169	110170	110171	110016	110017	110017	110018	110018			
110077	110078	110079	110080	110081	110081	110082	110082			
150640	150641	150642	150643	150644	150644					

107936	107937	108049	108050	108051	108051	108052	108052	105081	105098	105098
107938	107939	108057	108058	108059	108059	108060	108060	105085	105101	105101
		153324	148771		153319					

107592	107593	107594	107595	107596	107596	107597	107597			
107602	107603	107604	107605	107644	107644	107645	107645			
150647	147218	147181	147361	151398	151398					

109499	109501	109502	109503	109504						
108581	108582	107637	107638	107639	107639	107640	107640	105103	105107	105107
108583	108584	107579	107580	107581	107581	107582	107582	105105	105109	105109

	74	80	100	125	140
--	----	----	-----	-----	-----

Unstepped jaw in special length

Unstepped

SOFT

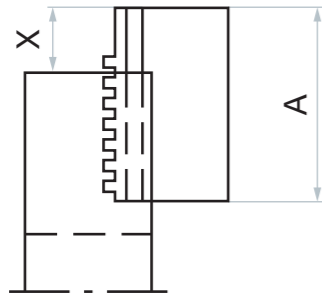

Dimension A					
Dimension X					
3-jaw set					
4-jaw set					
Dimension A					
Dimension X					
3-jaw set					
4-jaw set					
Dimension A					
Dimension X					
3-jaw set					
4-jaw set					

Top jaw in special length

Unstepped

SOFT

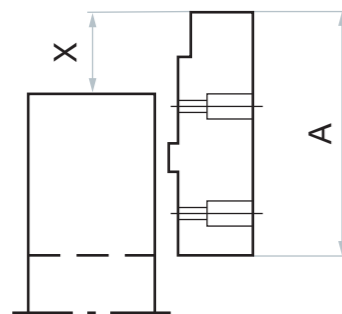

Dimension A					
Dimension X					
3-jaw set					
4-jaw set					
Dimension A					
Dimension X					
3-jaw set					
4-jaw set					
Dimension A					
Dimension X					
3-jaw set					
4-jaw set					

	160	200	250	315	350	400	500	630	800	1000	1250
--	-----	-----	-----	-----	-----	-----	-----	-----	-----	------	------

100	160	160	160	220	220	220					
50	56	70	70	70	80	80					
130031	132658	132184	137075	137075	131540	131540					
137073	137074	129894	130442	130442	137079	137079					
120	140	200	200	200	280	280					
70	76	110	110	110	140	140					
130033	128880	118908	137079	137079	137081	137081					
137077	130610	137078	137080	137080	137082	137082					
		250	250	250							
		160	160	160							
		121367	137087	137087							
		133691	137088	137088							
100	130	160	160	160	170	170					
43	63	76	53	53	75	75					
110086	112122	110624	110626	110626	103014	103014					
148139	129289	143764	141277	141277	103393	103393					
120	150	200	200	200	220	220					
63	83	116	93	93	125	125					
112120	125428	112091	112118	112118	110632	110632					
148657	128700	147754	141263	141263	148234	148234					
	180	250	260	260	280	280					
	113	166	153	153	185	185					
	104710	112089	10354	10354	112127	112127					
	146013	147860	149974	149974	148235	148235					

	74	80	100	125	140
--	----	----	-----	-----	-----

Unstepped jaw in special height

Unstepped

SOFT

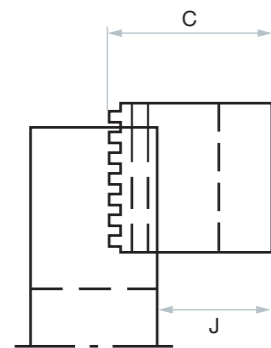

Dimension C					
Dimension J					
3-jaw set					
4-jaw set					
Dimension C					
Dimension J					
3-jaw set					
4-jaw set					
Dimension C					
Dimension J					
3-jaw set					
4-jaw set					

Top jaw in special height

Unstepped

SOFT

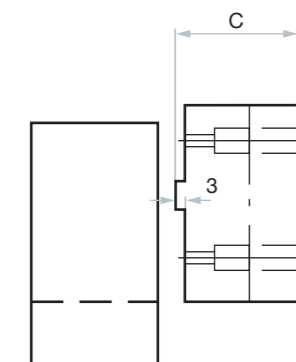

Dimension C					
3-jaw set					
4-jaw set					
4-jaw set					
Dimension C					
3-jaw set					
4-jaw set					
4-jaw set					
Dimension C					
3-jaw set					
4-jaw set					

160	200	250	315	350	400	500	630	800	1000	1250
-----	-----	-----	-----	-----	-----	-----	-----	-----	------	------

80	100	110	110	110	150	150				
58.5	73	76	72	72	110	110				
125710	122188	132186	137092	137092	137093	137093				
132972	134796	137091	131655	131655	137094	137094				
120	130	140	140	140	200	200				
98.5	103	106	102	102	160	160				
125712	122189	137096	137098	137098	125117	125117				
137095	130630	137097	137099	137099	137100	137100				
150	150	160	160	160						
128.5	123	126	122	122						
125714	137102	137104	132879	132879						
137101	137103	130340	110109	110109						
60	70	80	90	90	100	100				
132155	119645	110435	126385	126385	128590	128590				
132181	135867	149975	118373	118373	149985	149985				
148139	129289	143764	141277	141277	103393	103393				
80	100	110	120	120	130	130				
128564	128571	110437	110628	110628	110630	110630				
149976	134999	129691	135426	135426	149977	149977				
148657	128700	147754	141263	141263	148234	148234				
	150	150	160	160	160	160				
	128573	128569	128567	128567	128588	128588				
	149978	141671	139591	139591	140427	140427				

	74	80	100	125	140
--	----	----	-----	-----	-----

Top jaw in special width and height

Unstepped

SOFT

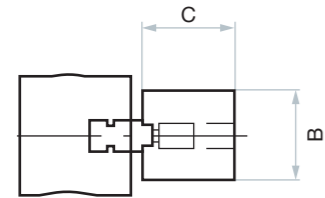

Dimension B					
Dimension C					
3-jaw set					
4-jaw set					
Dimension B					
Dimension C					
3-jaw set					
4-jaw set					

160	200	250	315	350	400	500	630	800	1000	1250
-----	-----	-----	-----	-----	-----	-----	-----	-----	------	------

40	50	60	60		80					
70	80	90	90		110					
105057	137090	143063	131567		137064					
105061	141338	149979	149980		149981					
50	60	80	80							
80	90	110	110							
133259	133653	143057	137086							
149982	137526	149983	149984							

CHIP PROTECTOR

A compatible chip protector is available to prevent chips getting into the jaw guides



Chuck size	100	125	140	160	200	250	315	300	400	500	630
ID#	108501	108502	108503	108503	108504	108505	108506	108506	108506	108508	108508

JAW STEP CLAMPING RANGES (GUIDELINE VALUES)

EXTERNAL CLAMPING

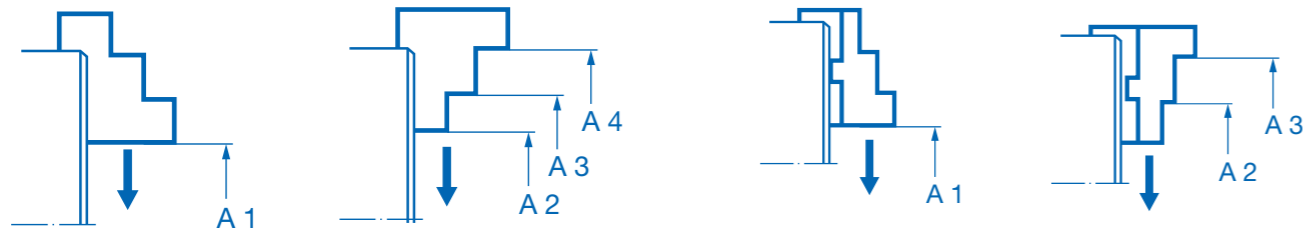

Size	74	80	100	125	140	160	200	250
A1 (BB)	2-24	2-30	3-38	3-53	3-53	3-72	4-100	5-122
A2 (DB)	2-24	2-30	3-38	3-53	3-53	3-72	4-100	5-122
A3 (DB)	23-46	27-55	38-71	39-89	47-97	47-116	56-152	73-190
A4 (DB)	45-68	52-80	70-100	75-125	91-140	91-160	104-200	131-250
Maximum circumferential Ø	88	104	128	157	174	194	238	302
Jaw stroke	11	14	15	25	25	34	48	58

315	350	400	500	630	700	800	1000	1250
6-135	20-180	20-200	35-260	50-350	110-350	150-450	250-600	320-600
6-135	20-180	20-200	35-260	50-350	280-672	325-853	425-1070	490-1150
96-225	110-270	110-300	140-360	190-490	356-748	400-928	500-1150	564-1224
186-315	200-350	200-400	280-500	330-630	-	-	-	-
395	440	480	600	730	1000	1170	1390	1476
64	80	100	110	150	120	150	175	140

INTERNAL CLAMPING

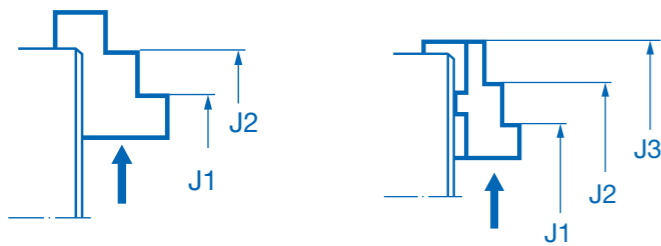

Size	74	80	100	125	140	160	200	250
J1	23-46	25-53	33-66	37-87	39-89	39-107	44-140	59-165
J2	45-68	50-78	65-94	73-123	83-132	83-152	92-186	119-236
J3	-	-	-	-	-	-	-	-

315	350	400	500	630	700	800	1000	1250
96-224	100-260	100-300	135-355	150-450	212-648	251-855	356-1080	426-1162
186-305	190-350	190-390	275-460	290-590	290-758	326-930	430-1150	500-1236
-	-	-	-	-	526-922	566-1094	660-1314	740-1400

These values are applicable for 3 and 4-jaw chucks and lathe chucks with reversible jaws. The maximum clamping ranges must not be exceeded.

INSTALLATION

FOR CONCENTRICITY

The jaws and lathe chuck are equally responsible for precise clamping. Therefore, especially for demanding precision machining tasks, it is vital for the jaws to be optimally coordinated with the lathe chuck. RÖHM supplies jaw cutting attachments (BAV) for this purpose. They enable hard and soft jaws to be turned and finish ground while installed on the lathe chuck. It is suspended in the holes available in the base/top jaws. Jaws without holes have to be modified accordingly or clamping is carried out on the BAV jaws.



Size	0	1	2	3	4	5
Chuck size	125	200	250	250	315	400
Suspension distance (internal suspension)	50-115	35-125	70-140	100-175	145-215	160-270
Suspension distance (external suspension)	150-215	170-260	215-285	145-215	290-360	330-440
ID#	220206	220207	220208	220209	220210	220211

1. Position jaw



2. Pre-position the jaw cutting attachment



3. Tighten the clamping jaw and cut the jaws



4. Check the boring diameter



5. Loosen the jaw cutting attachment

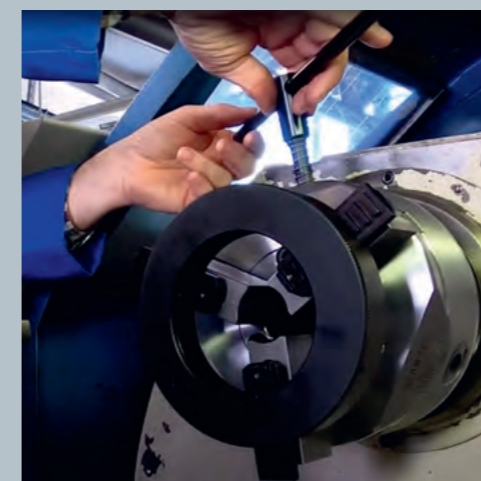

See the video:



INSTALLATION

HOW DO YOU INSTALL THE DURO-M ONTO YOUR MACHINE TOOL?

Standard DIN/ISO mountings and 3-way fitting

The DURO-M comes with the appropriate mounting for the spindle on your machine tool:

CYLINDRICAL MOUNTING

- DIN6350, Form A for rear fitting
- DIN6350, mounting from front

SHORT TAPER MOUNTING

- ISO 702-1/DIN 55026, mounting from front
- ISO 702-2/DIN 55029 (Camlock) with studs
- ISO 702-3/DIN 55027 (bayonet) with studs and collar nuts



Adapter plates for finishing for adaptation to short taper mountings for maximum accuracy

For maximum accuracy of the machine tool / spindle / machine system, it may be necessary to create the connection to the machine tool spindle when installed. Adapter plates that are finished on the machine side and provide a short taper (mounting from front [ISO 702-1/DIN 55026], Camlock [ISO 702-2/DIN 55029] or bayonet mounting [ISO 702-3/DIN 55027]) are available.

On the chuck side, these adapter plates are only faced and provide sufficient material to incorporate a custom connection, for example a cylindrical mounting.

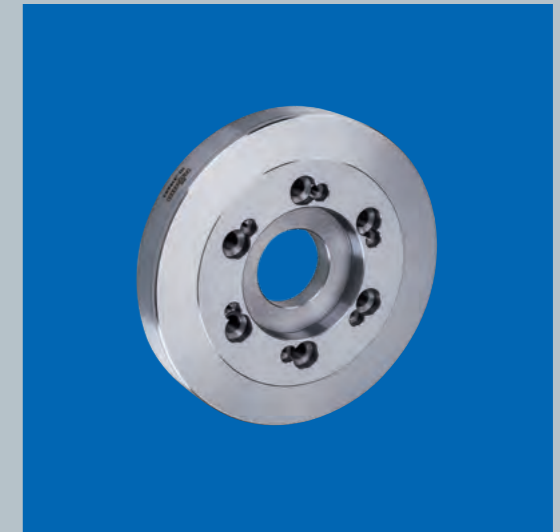

Chucks finished on machine side

Adapter plates for adaptation of cylindrical to short taper mountings

Do you have a DURO-M with cylindrical mounting (DIN6350, modified, with mounting from front) and want to adapt it for a machine tool with a short taper mounting (ISO 702-1, DIN 55026)? Then choose one of the finished adapter plates from RÖHM.

Six threads, each offset by 60°, are available for attachment to the chuck.

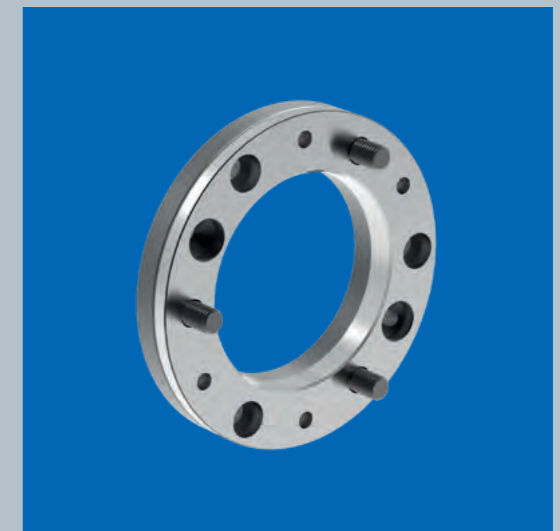

Finished adapter plates

INSTALLATION



HOW DO YOU MOUNT THE DURO-M ONTO YOUR MACHINE TABLE?

Base plates for installation on machine table

The DURO-M is also used for clamping rotationally symmetrical workpieces without turning them. Examples include milling or use on measuring machines. For this purpose, there are adapter plates that hold a DURO-M with cylindrical mounting (DIN6350, Form A or

with mounting from front in accordance with DIN 6350, modified). For attachment on the table, there are two opposite T-grooves for mounting screws, as well as a wide edge for attachment using clamps (brackets).

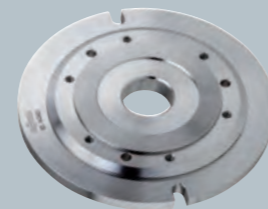

Adapter plate for mounting on tables

Ø 74-160

Chuck size	74	80	100	125			160			
FROM ADAPTER RECESS TO SHORT TAPER, MACHINED ON BOTH SIDES										
Short taper	-	-	-	3	4	5	6	3	4	5
ISO 702-1 (mounting from front) *	-	-	-	182900	182902	182904	182906	-	182908	182910
ISO 702-2 (Camlock)				182956	182958	182960	182962	182964	182966	182968
ISO 702-3 (studs and collar nuts)				183012	183014	183016	183018	183020	183022	183024
ON SHORT TAPER MOUNTING, CHUCK SIDE, UNMACHINED										
KK	-	-	-	3	4	5	6	3	4	5
ISO 702-2 (Camlock)	-	-	-	319673	319674	-	-	319675	319676	319677
ISO 702-3 (studs and collar nuts)	-	-	-	319650	319651	-	-	319652	319653	319654
FROM ADAPTER RECESS ON MOUNTING PLATE										
Chuck size				125				160		
ID#				131335				162793		

Ø 160-250

Chuck size	160			200			250			
FROM ADAPTER RECESS TO SHORT TAPER, MACHINED ON BOTH SIDES										
Short taper	6	8	4	5	6	8	4	5	6	8
ISO 702-1 (mounting from front) *	182912	182914	182916	182918	182920	182922	-	182924	182926	182928
ISO 702-2 (Camlock)	182970	182972	182974	182976	182978	182980	182982	182984	182986	182988
ISO 702-3 (studs and collar nuts)	183026	183028	183030	183032	183034	183036	183038	183040	183042	183044
ON SHORT TAPER MOUNTING, CHUCK SIDE, UNMACHINED										
KK	6	8	4	5	6	8	4	5	6	8
ISO 702-2 (Camlock)	-	-	319678	319679	319680	-	319681	319682	319683	319684
ISO 702-3 (studs and collar nuts)	-	-	319655	319656	319657		319658	319659	319660	319661
FROM ADAPTER RECESS ON MOUNTING PLATE										
Chuck size				200				250		
ID#				162401				163036		

Ø 315-400

Chuck size	315				400			
FROM ADAPTER RECESS TO SHORT TAPER, MACHINED ON BOTH SIDES								
Short taper	5	6	8	11	6	8	11	15
ISO 702-1 (mounting from front) *	-	182930	182932	182934	182936	182938	182940	182942
ISO 702-2 (Camlock)	182990	182992	182994	182996	182998	183000	183002	183004
ISO 702-3 (studs and collar nuts)	183046	183048	183050	183052	183054	183056	183058	183060
ON SHORT TAPER MOUNTING, CHUCK SIDE, UNMACHINED								
KK	5	6	8	11	6	8	11	15
ISO 702-2 (Camlock)	319685	319686	319687	319688	319689	319690	319691	319692
ISO 702-3 (studs and collar nuts)	319662	319663	319664	319665	319666	319667	319668	319669
FROM ADAPTER RECESS ON MOUNTING PLATE								
Chuck size	315				400			
ID#	133705				133706			

Ø 500-630

Chuck size	500			630		
FROM ADAPTER RECESS TO SHORT TAPER, MACHINED ON BOTH SIDES						
Short taper	8	11	15	11	15	20
ISO 702-1 (mounting from front) *	182944	182946	182948	182950	182952	182954
ISO 702-2 (Camlock)	183006	183008	183010			
ISO 702-3 (studs and collar nuts)	183062	183064	183066			
ON SHORT TAPER MOUNTING, CHUCK SIDE, UNMACHINED						
KK	8	11	15	11	15	20
ISO 702-2 (Camlock)	319693	319694	319695	**	**	**
ISO 702-3 (studs and collar nuts)	319670	319671	319672	**	**	**
FROM ADAPTER RECESS ON MOUNTING PLATE						
Chuck size	-			-		
ID#	-			-		

* This flange cannot be used for chucks with DIN6350, form A cylindrical mounting but is only suitable for chucks with DIN6350 modified, front attachment cylindrical mounting.

** On request

INSTALLATION

CHECK EDGE FOR CONCENTRICITY MEASUREMENT

A check edge is worked into the rear section of the chuck. Here, a dial gage can be used to measure the concentricity of the chuck on your machine tool.

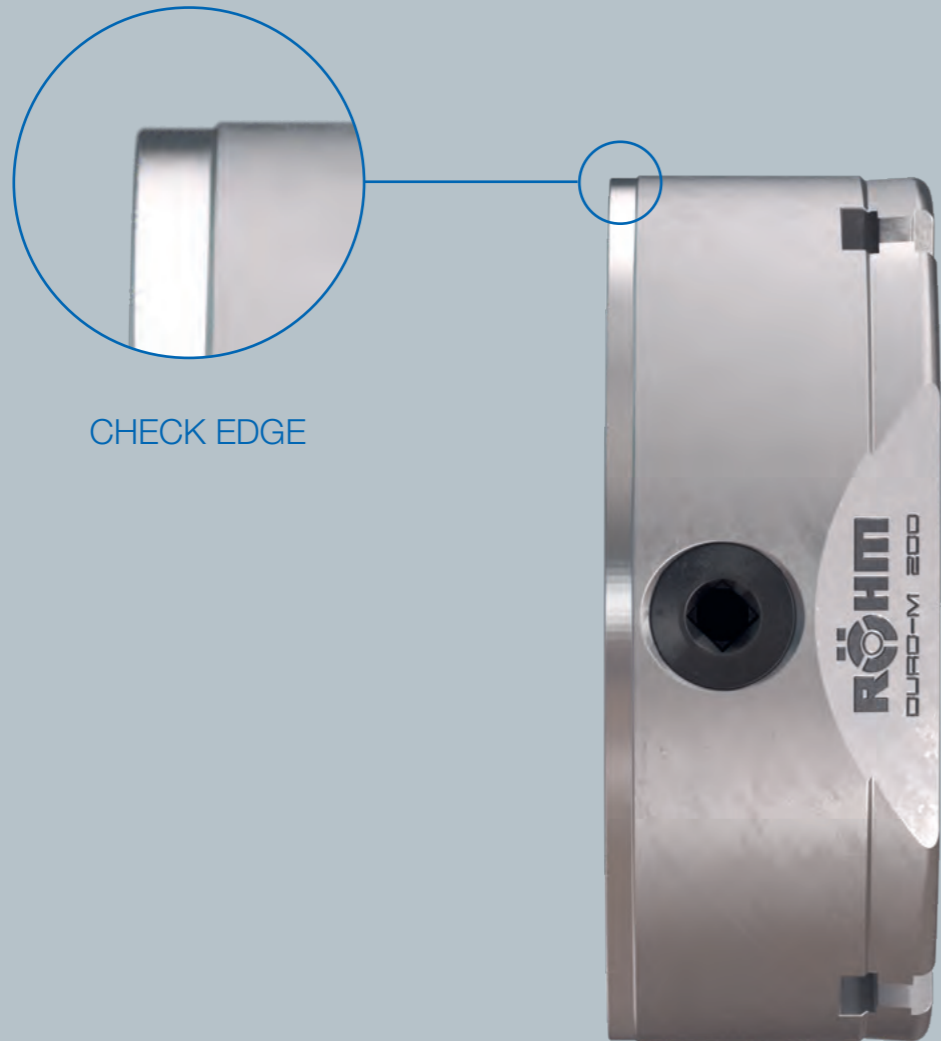

CHECK EDGE

FOR TURNING OVER THE ENTIRE LENGTH

Clamping using face drivers is a suitable method for machining rotationally symmetrical parts over their entire length. The CoAE from RÖHM is the perfect solution. The DURO-M helps you to clamp the face driver precisely and securely.

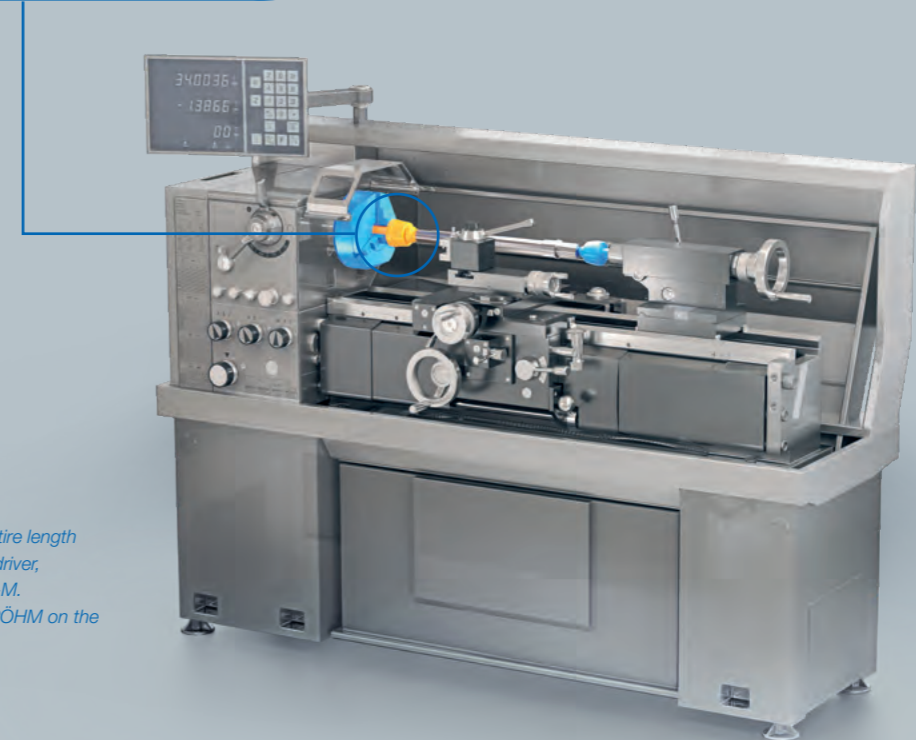
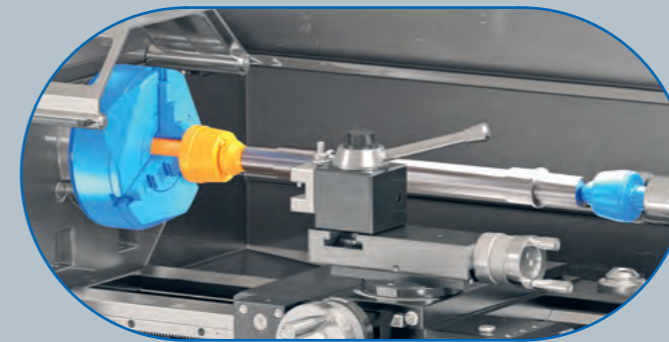

Machine over the entire length with the CoAE face driver, clamped in a DURO-M. With a center from RÖHM on the tail stock side.



You can find out more about the face driver that can do (almost) anything in our CoAE brochure

INSTALLATION

FOR CHANGING



Appropriate chuck keys are available for changing the jaws. They are inserted in one of the three drives and the chuck is opened until the jaws are no longer engaged in the scroll ring and can be removed by hand.

The appropriate chuck key is included with your DURO-M.



To protect the ejector spring, the chuck key is available with an additional sliding sleeve over the spring as a safety key.

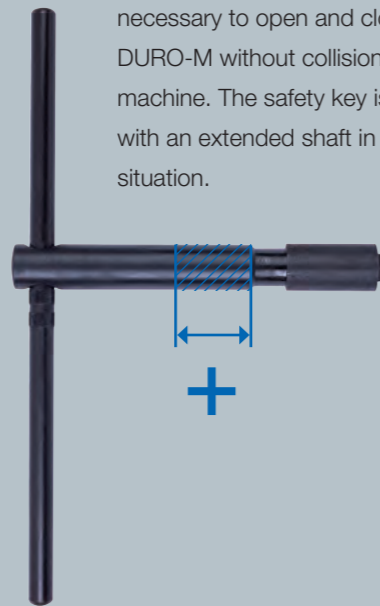

If the head stock of a turning machine has a large volume and/or is very high, a longer chuck key may be necessary to open and close the DURO-M without collision with the machine. The safety key is available with an extended shaft in this situation.

CHUCK KEY

Chuck size	Version	74	80	100	125	140	160	200	250	315	350	400	500	630
Square		-	6	8	9	9	10	11	12	14	14	17	19	19
Hexagon		6												
ID#	Standard	6325	107426	107427	107428	107428	107429	107430	107431	107432	107433	107434	107435	107435
ID#	Safety key	-	154370	154371	154372	-	154373	154374	154375	154376	154377	154378	154379	154379
ID#	Safety key with long shaft	-	-	-	154683	-	154685	154687	154689	-	-	-	-	-



RÖHM supplies the appropriate torque wrench in sizes 20-120 Nm and 60-320 Nm (order number: 10004116 / 10004117)

Particularly for sensitive workpieces, either with surfaces that can easily be compressed, or with low wall sections that could easily be deformed during clamping, the correct clamping force is absolutely crucial. If the clamping force is too high, the workpiece will be damaged, but if the clamping force is too low, the cutting forces will not be fully transmitted. Therefore, clamping the DURO-M with a torque wrench is recommended.

Adapters are available for using a torque wrench with imperial measurement square for adjusting the drive on the DURO-M. They are fitted with a safety spring, which means that they cannot inadvertently be left in the drive after clamping and then ejected later.



Adapters for use of a torque wrench

ADAPTER FOR TORQUE SPANNER

Version	74	80	100	125	140	160	200	250	315	350	400	500	630
Square for torque spanner [inch]	-	3/8	1/2	1/2	1/2	1/2	1/2	1/2	1/2	1/2	1/2	3/4	3/4
ID#	-	178566	178567	178568	178568	178569	178570	178571	178572	178572	178573	178574	178574

TECHNOLOGY

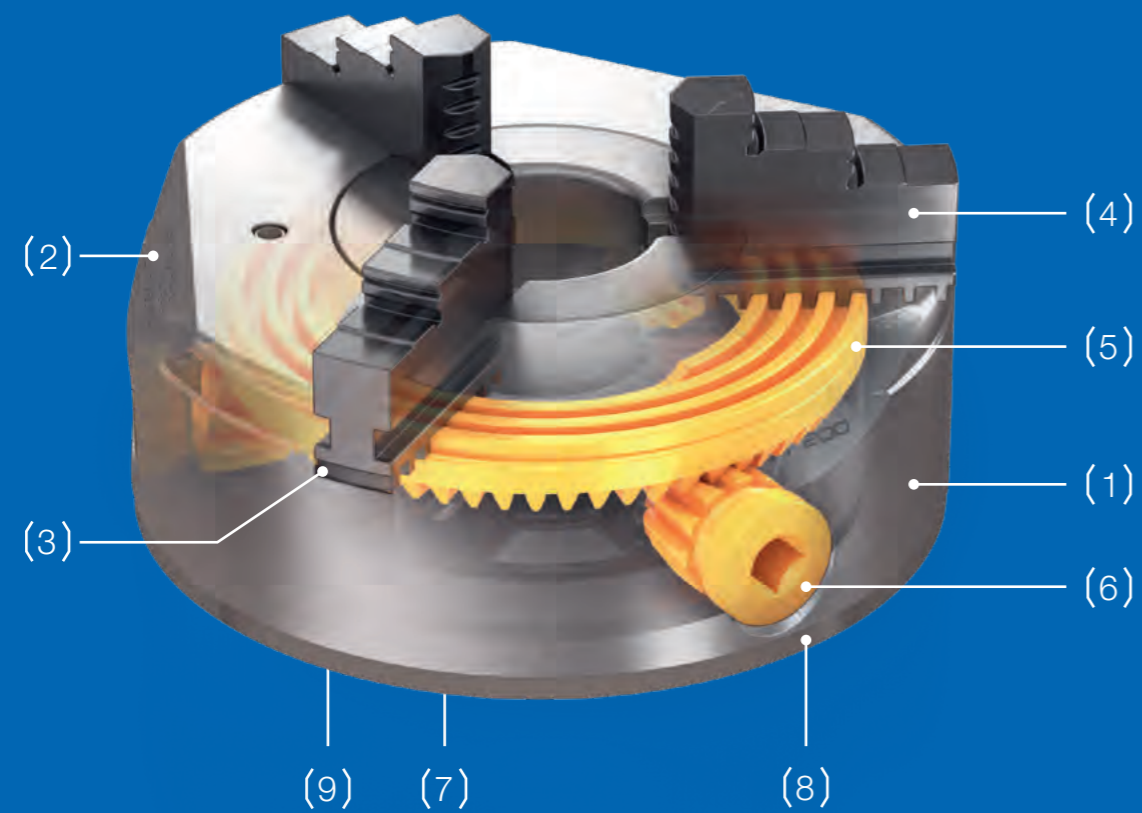

- (1) Chuck body
- (2) Lenses
- (3) Jaw guide
- (4) Clamping jaws
- (5) Scroll ring
- (6) Drive
- (7) Cover
- (8) Check edge
- (9) Mounting screws

HOW THE DURO-M FROM RÖHM WORKS

The DURO-M can be used for centric clamping of rotationally symmetrical components. Clamping is carried out using clamping jaws (4), which clamp axially to the axis of rotation using a suitable adjustment device. On scroll chucks such as the DURO-M this is done using a scroll ring (5). Spiral-shaped guideways are worked into its upper side. The undersides of the clamping jaws engage in these guideways. When the scroll ring is rotated, the clamping jaws move radially and clamp (or release) the workpiece.

The spiral ring is rotated using one of several drives (6), which are toothed to match the tothing on the underside of the spiral ring. To adjust the chuck, the clamping key is inserted into the head of one of the drives and then turned. The drives are locked in place using the drive retaining screws.

The entire mechanism, consisting of the drive and spiral ring, is inserted in the chuck body (1) and guided into it. The one-piece construction means that the design is very rigid. On the rear it is sealed by the cover (7) with screws.



Figure 1:
The undersides of the clamping jaws engage in the spirals on the spiral ring.

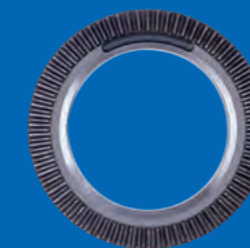

The drive and spiral ring have matching tothing



The drive is locked in place using the drive retaining screw

TECHNOLOGY

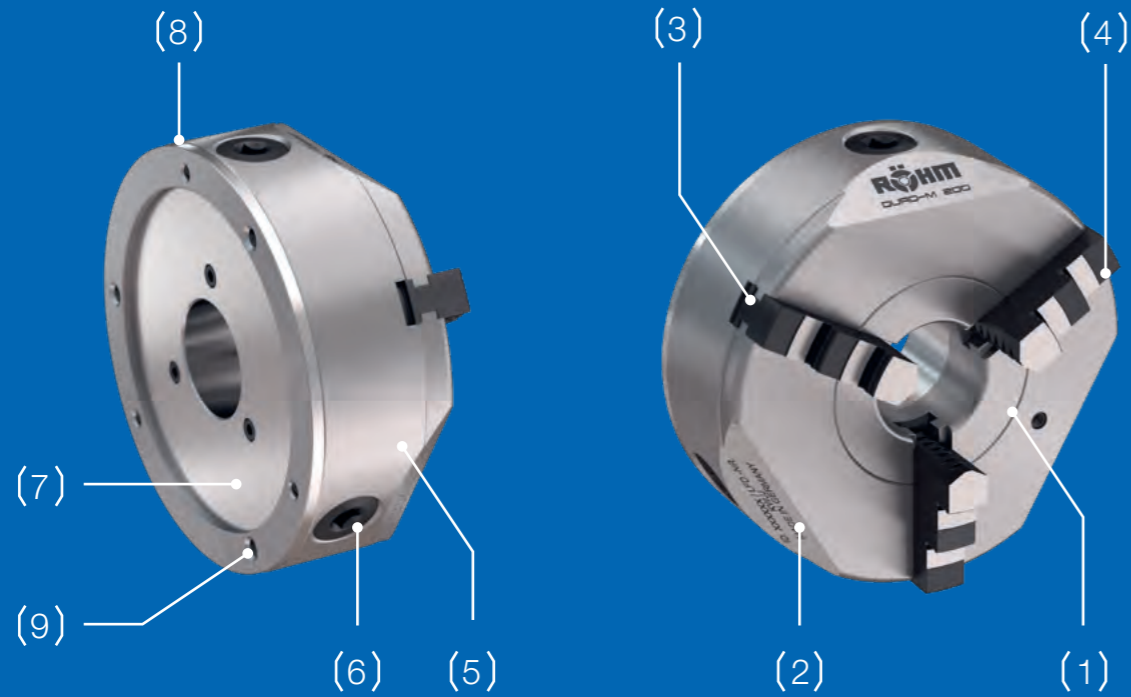

Due to the principle (including manufacturing tolerances) there is one drive that is more precise than the others. This so-called "zero drive" is identified during manufacture of the chuck by RÖHM and is clearly indicated by an arrow. The first time the jaws are finish ground (also during manufacturing by RÖHM), this drive is used for clamping.



... that the efficiency of your lathe chuck depends to a great extent on the lubrication. If you think about it for a moment, it is obvious: the more easily the toothing on the drive, spiral spring, jaw toothing and jaw guides "moves", the more clamping force is applied at the clamping point, rather than being expended to overcome friction. RÖHM supplies the perfect accessories for lubricating your DURO-M.

GOOD TO KNOW

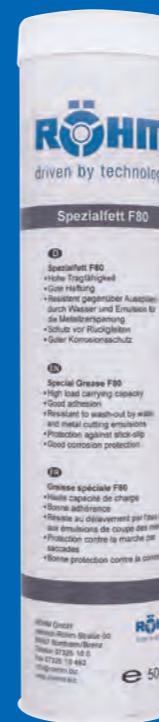

RÖHM F80 special grease in 500g cartridge for lubricant application with grease gun

RÖHM F80 special grease in 1,000g tin for lubricant application with brush

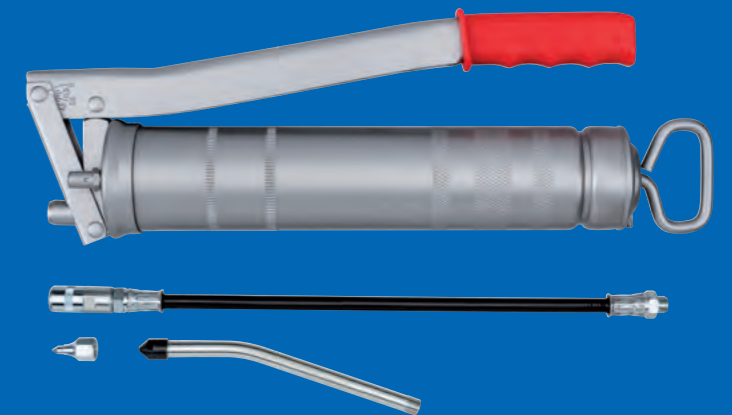

RÖHM grease gun for application of F80 lubricant from the cartridge

You can find further information about the DURO-M on our website:

ROEHM.BIZ/DURO-M

YOU SAY: MANUAL SCROLL CHUCK? WE SAY: DURO-M!

What size, what spindle mounting, how many jaws, which jaw guides do you want?

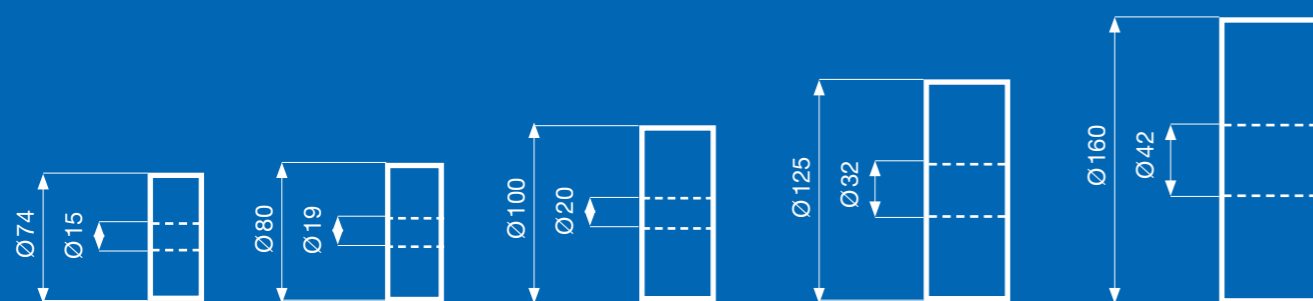
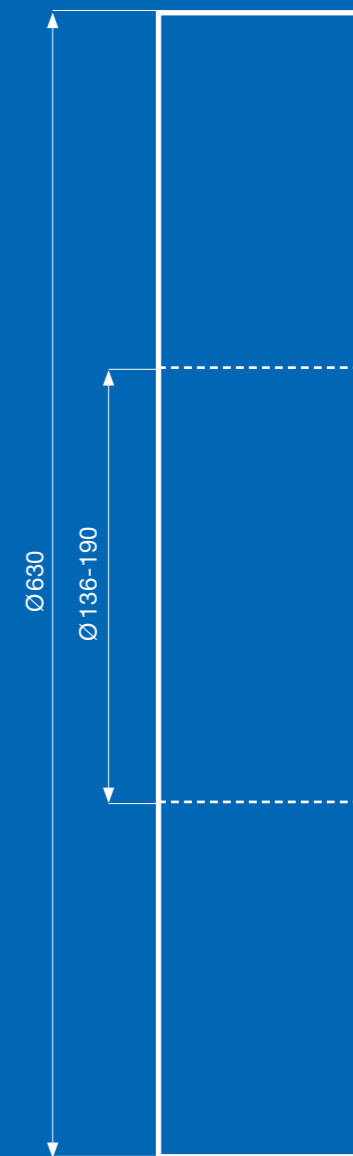
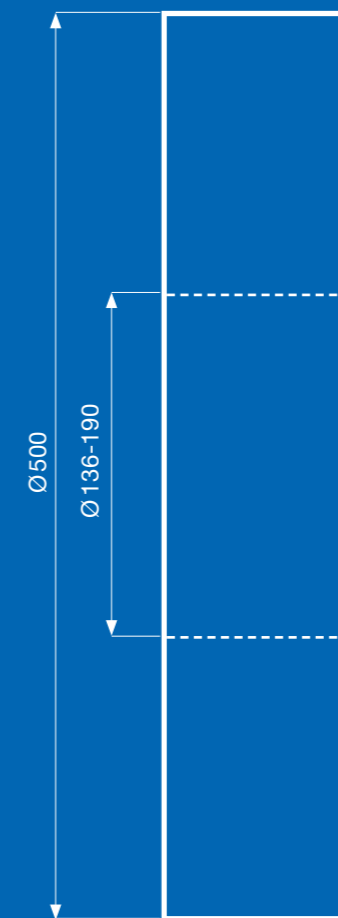
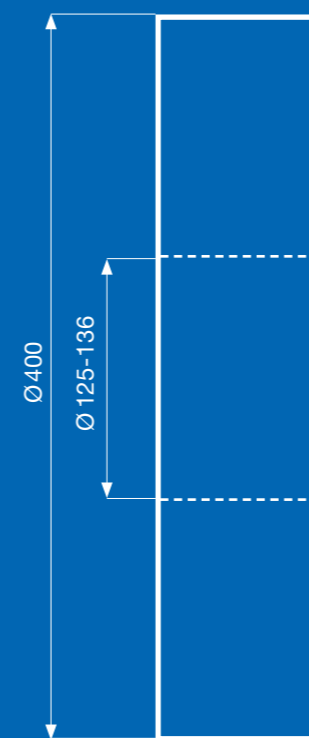
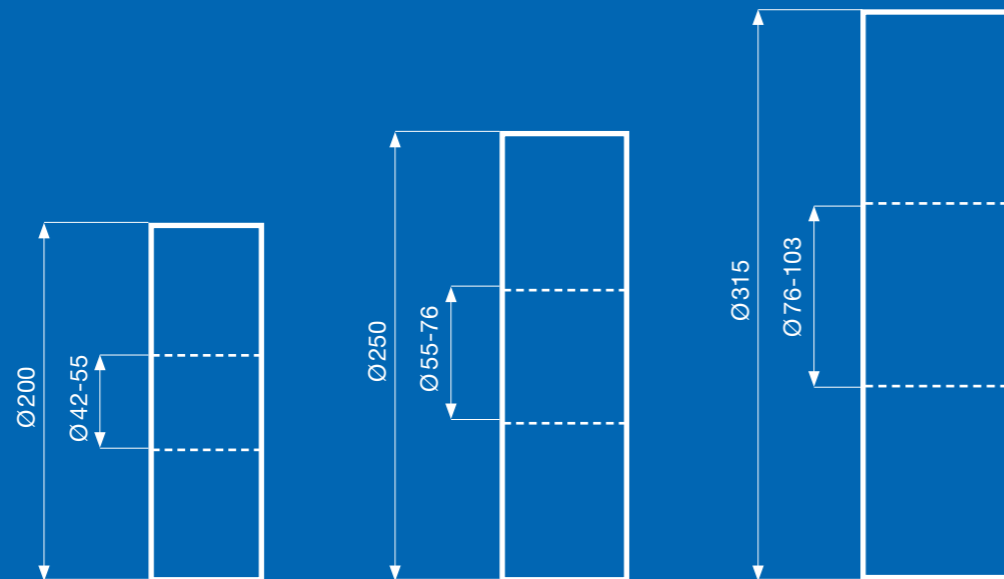

CHUCK PASSAGE DEPENDING ON THE VERSION

NUMBER OF JAWS

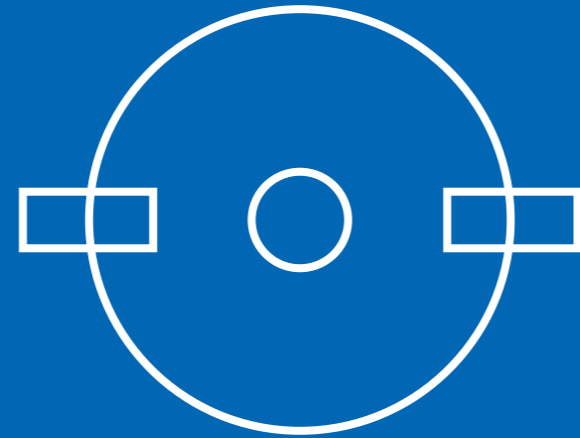
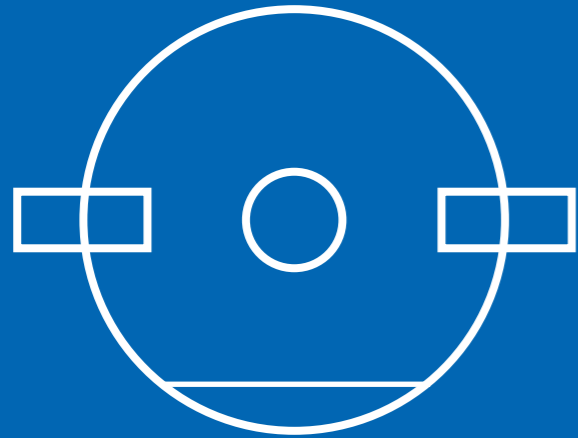

Two-jaw chucks from size 400 have no lenses.

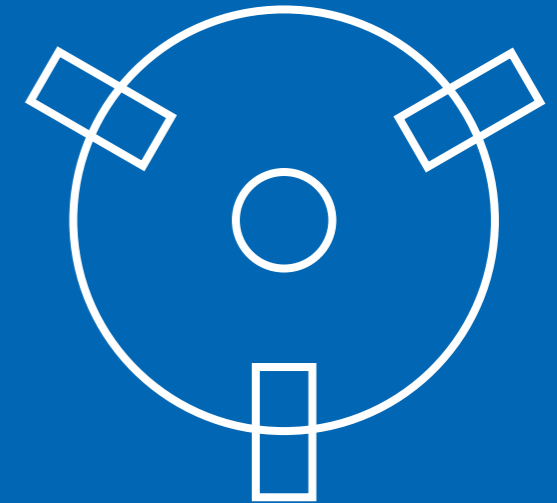

Three-jaw chucks from size 400 have no lenses.

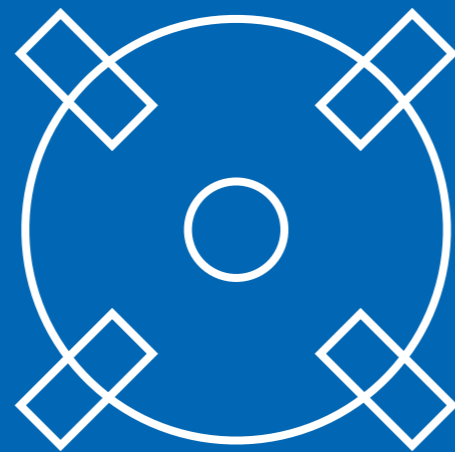
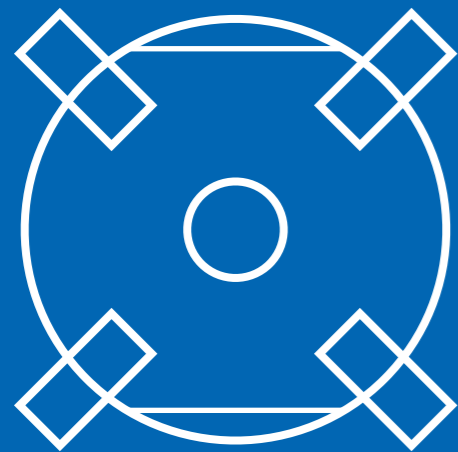

Four-jaw chucks from size 400 and all chucks with front attachment have no lenses.

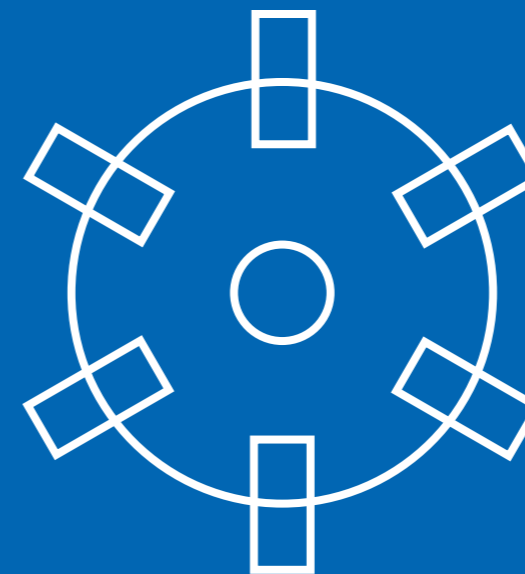

Based on the way they are designed, six-jaw chucks are only available without lenses.

JAW GUIDES

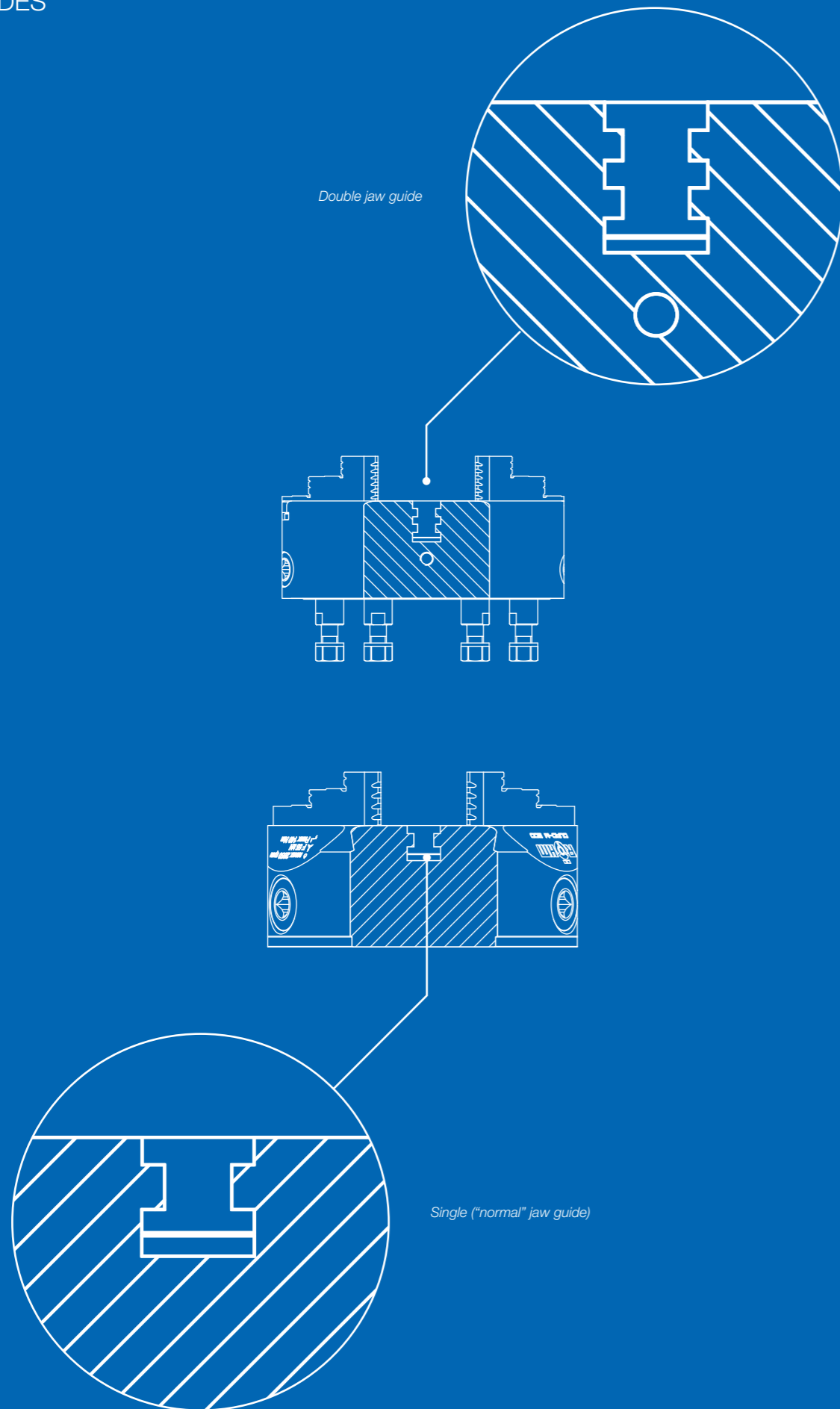

MOUNTING

CYLINDRICAL MOUNTING

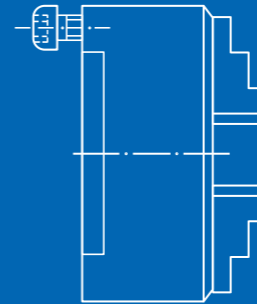

DIN6350, Form A for rear fitting

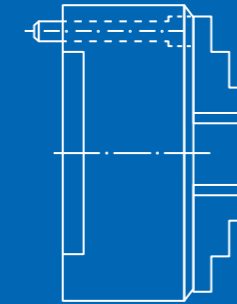

DIN6350, mounting from front

SHORT TAPER MOUNTING

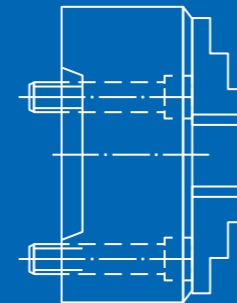

ISO 702-1/DIN 55026, mounting from front

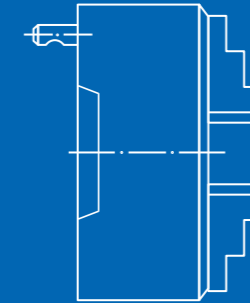

ISO 702-2/DIN 55029 (Camlock) with studs

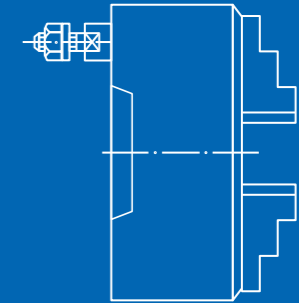

ISO 702-3/DIN 55027 (bayonet) with studs and collar nuts



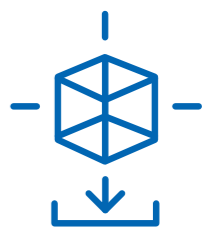

You can find CAD data for the DURO-M at

www.roehm.biz/duro-m







DIN 6350, ADAPTER RECESS, FORM A





Ø 74 - 200

		74	80	100	125	140	160	200
	Adapter recess [mm]	56	56	70	95	105	125	160
 2-Jaw								
Base and top jaws	ID#			185587	185588		185589	185590
 3-Jaw								
Inside and outside jaws	ID#	185299	185300	185301	185302	185585	185303	185304
Base and top jaws	ID#			185310	185311		185312	185313
 4-Jaw								
Inside and outside jaws	ID#		185323	185324	185325		185326	185327
Base and top jaws	ID#			185333	185334		185335	185336
 6-Jaw								
Inside and outside jaws	ID#						185347	185348

Ø 250 - 315





		250	315
	Adapter recess [mm]	200	260
 2-Jaw			
Base and top jaws	ID#	185591	185592
 3-Jaw			
Inside and outside jaws	ID#	185305	185306
Base and top jaws	ID#	185314	185315
 4-Jaw			
Inside and outside jaws	ID#	185328	185329
Base and top jaws	ID#	185337	185338
 6-Jaw			
Inside and outside jaws	ID#	185349	185350

Ø 400 - 1250

		400	500	630	700	800	1000	1250
	Adapter recess [mm]	330	420	545	610	710	910	910
 2-Jaw								
Base and top jaws	ID#	185593						
 3-Jaw								
Inside and outside jaws	ID#	185307	185308	185309				
Base and top jaws	ID#	185316	185317	185318	185319	185320	185321	185322
 4-Jaw								
Inside and outside jaws	ID#	185330	185331	185332				
Base and top jaws	ID#	185339	185340	185341	185342	185343	185344	185345
 6-Jaw								
Inside and outside jaws	ID#	185351						

DIN 6350, ADAPTER RECESS, MOUNTING FROM FRONT





Ø 74 - 200

		125	160	200
	Adapter recess [mm]	95	125	160
 2-Jaw				
Base and top jaws	ID#	185594	185595	185596
 3-Jaw				
Inside and outside jaws	ID#	185359	185360	185361
 4-Jaw				
Inside and outside jaws	ID#	185367	185368	185369
 6-Jaw				
Inside and outside jaws	ID#		185600	185601

Ø 250 - 315



		250	315
	Adapter recess [mm]	200	260
 2-Jaw			
Base and top jaws	ID#	185597	185598
 3-Jaw			
Inside and outside jaws	ID#	185362	185363
 4-Jaw			
Inside and outside jaws	ID#	185370	185371
 6-Jaw			
Inside and outside jaws	ID#	185602	185603

Ø 400 - 1250



		400	500	630
	Adapter recess [mm]	330	420	545
 2-Jaw				
Base and top jaws	ID#	185599		
 3-Jaw				
Inside and outside jaws	ID#	185364	185365	185366
 4-Jaw				
Inside and outside jaws	ID#	185372	185373	185374
 6-Jaw				
Inside and outside jaws	ID#	185604		

ISO 702-1 (DIN 55026), MOUNTING FROM FRONT



Ø 74-200

		160	200	200
	Short taper mounting	5	5	6
	3-Jaw			
Inside and outside jaws	ID#	185375	185376	185377
Base and top jaws	ID#	185389	185390	185391
	4-Jaw			
Inside and outside jaws	ID#	185402	185403	185404
Base and top jaws	ID#	185417	185418	185419

Ø 250-315



		250	250	250	315	315
	Short taper mounting	5	6	8	6	8
	3-Jaw					
Inside and outside jaws	ID#	185378	185379	185380	185381	185382
Base and top jaws	ID#	185392	185393	185394	185395	185396
	4-Jaw					
Inside and outside jaws	ID#	185405	185406	185407	185408	185409
Base and top jaws	ID#	185420	185421	185422	185423	185424

Ø 400-1250



		400	400	500	500	630	630	700	800	1000	1250
	Short taper mounting	8	11	8	11	11	15	11	11	15	15
	3-Jaw										
Inside and outside jaws	ID#	185383	185384	185385	185386	185387	185388				
Inside and outside jaws	ID#	185397	185398		185399	185400	185401				
	4-Jaw										
Base and top jaws	ID#	185412	185413		185414	185415	185416				
Base and top jaws	ID#	185427	185428		185429	185430	185431				

ISO 702-2 (DIN 55029), CAMLOCK



Ø 74-200

		125	125	160	160	200	200	200
	Short taper mounting	3	4	4	5	3	5	6
	3-Jaw							
Inside and outside jaws	ID#	185432	185433	185434	185435		185436	185437
Base and top jaws	ID#	185450	185451	185452	185453		185454	185455
	4-Jaw							
Inside and outside jaws	ID#		185468	185469	185470		185471	185472
Base and top jaws	ID#		185484	185485	185486		185487	185488

Ø 250-315



		250	250	250	250	315	315	315
	Short taper mounting	4	5	6	8	6	8	11
	3-Jaw							
Inside and outside jaws	ID#			185438	185439	185440	185441	185442
Base and top jaws	ID#			185456	185457	185458	185459	185460
	4-Jaw							
Inside and outside jaws	ID#			185473	185474	185475	185476	185477
Base and top jaws	ID#			185489	185490	185491	185492	185493

Ø 400-1250



		400	400	500	500	500	630	630	700	800	1000	1250
	Short taper mounting	8	11	8	11	15	11	15	11	11	15	15
	3-Jaw											
Inside and outside jaws	ID#	185443	185444	185445	185446	185447	185448	185449				
Base and top jaws	ID#	185461	185462	185463	185464	185465	185466	185467				
	4-Jaw											
Inside and outside jaws	ID#	185478	185479		185480	185481	185482	185483				
Base and top jaws	ID#	185494	185495		185496	185497	185498	185499				

ISO 702-3 (DIN 55027), BAYONET



Ø 74-200

		100	125	125	140	160	160	200	200	200
	Short taper mounting	3	3	4	3	4	5	3	5	6
	3-Jaw									
Inside and outside jaws	ID#	185500	185501	185502		185503	185504		185505	185506
Base and top jaws	ID#	185519	185520	185521		185522	185523		185524	185525
	4-Jaw									
Inside and outside jaws	ID#			185538		185539	185540		185541	185542
Base and top jaws	ID#			185554		185555	185556		185557	185558

Ø 250-315

		250	250	250	250	315	315	315
	Short taper mounting	4	5	6	8	6	8	11
	3-Jaw							
Inside and outside jaws	ID#			185507	185508	185509	185510	185511
Base and top jaws	ID#			185526	185527	185528	185529	185530
	4-Jaw							
Inside and outside jaws	ID#			185543	185544	185545	185546	185547
Base and top jaws	ID#			185559	185560	185561	185562	185563

Ø 400-1250

		400	400	500	500	500	630	630	700	800	1000	1250
	Short taper mounting	8	11	8	11	15	11	15	11	11	15	15
	3-Jaw											
Inside and outside jaws	ID#	185512	185513	185514	185515	185516	185517	185518				
Base and top jaws	ID#	185531	185532	185533	185534	185535	185536	185537				
	4-Jaw											
Inside and outside jaws	ID#	185548	185549		185550	185551	185552	185553				
Base and top jaws	ID#	185564	185565		185566	185567	185568	185569				

YOU NEED THE WHOLE SYSTEM ...

The DURO-M series manual lathe chucks are a key component for clamping on your machine tool. But precision clamping also requires other components. That's why we offer the complete system.

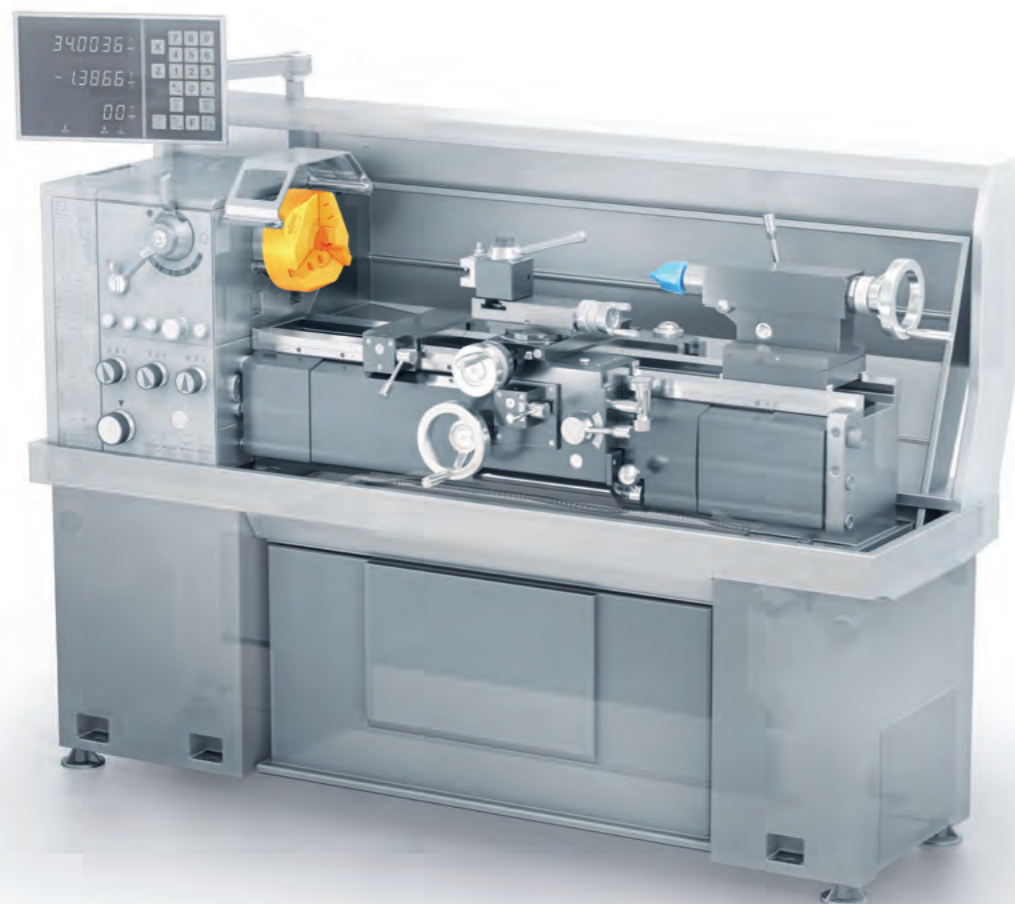

(1)



... to center long turned parts on the opposite side. That's what RÖHM centers are for.

(1)



... for incorporating holes on the face pointing away from the chuck. That's what RÖHM drill chucks are for.



You can buy clamping and gripping technology from RÖHM conveniently 24/7 in our online shop:

eshop247.roehm.biz

MAYBE YOU NEED SOMETHING ELSE ALTOGETHER ...

The DURO-M is the universally compatible lathe chuck for conventional applications. But maybe you have requirements that call for a special solution. Perhaps because you have different needs in terms of the geometries to be machined.

Or the volumes to be produced result in different general conditions. Whatever you need, at RÖHM we have the right clamping solution. That's our promise.

... because you need even higher clamping forces and concentricity. Then choose our manual lathe chuck that clamps using the wedge bar principle, the Duro-T.



... because you want automated clamping with high forces. That's what our power chuck with quick jaw change system, the Duro-A RC, is for.



... because you need a clamping device that you can use for end-to-end machining. Take a look at our CoAE face driver, which clamps turned parts on the face.



... because you want very precise clamping of small diameters. That's what our Captis-M manually operated collet chuck is for.



... because you want to clamp large diameters that may also be non-circular with high force for initial machining. Then opt for our USE/USU face plates.

